

SHRP
TE
251.5
.S57
1993
c. 1

SHRP-P-654

SHRP Procedure for Temperature Correction of Maximum Deflections

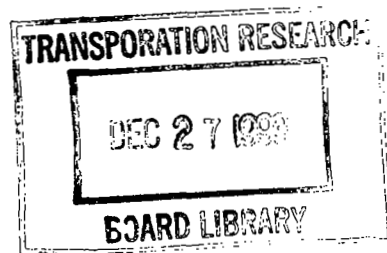

Strategic Highway Research Program
National Research Council

Strategic Highway Research Program Executive Committee

John R. Tabb, Chairman
Mississippi Highway Department

William G. Agnew
General Motors Research (retired)

E. Dean Carlson, *ex officio*
Federal Highway Administration

A. Ray Chamberlain
Colorado Department of Highways

Michael J. Cuddy
New York Department of Transportation

Raymond F. Decker
University Science Partners Inc.

Thomas B. Deen, *ex officio*
Transportation Research Board

Thomas M. Downs
New Jersey Department of Transportation

Francis B. Francois, *ex officio*
American Association of State Highway and Transportation Officials

William L. Giles
Ruan Transportation Management Systems

Jack S. Hodge
Virginia Department of Transportation

Donald W. Lucas
Indiana Department of Transportation

Harold L. Michael
Purdue University

Wayne Muri
Missouri Highway and Transportation Department

M. Lee Powell, III
Ballenger Paving Company, Inc.

Henry A. Thomason, Jr.
Texas Department of Highways and Public Transportation

Stanley I. Warshaw
National Institute of Standards and Technology

Roger L. Yarbrough
Apcon Corporation

Key SHRP Staff

Damian J. Kulash
Executive Director

Guy W. Hager
Implementation Manager

Edward T. Harrigan
Asphalt Program Manager

Kathryn Harrington-Hughes
Communications Director

Don M. Harriott
*Concrete & Structures/Highway
Operations Program Manager*

Harry Jones
Finance & Administration Director

SHRP-P-654

SHRP Procedure for Temperature Correction of Maximum Deflections

PCS/Law Engineering



Strategic Highway Research Program
National Research Council
Washington, DC 1993

SHRP-P-654
Contract P-001

Program Manager: *Neil F. Hawks*
Project Manager: *Cheryl Allen Richter*
Production Editor: *Marsha Barrett*
Program Area Secretary: *Cynthia Baker*

August 1993

key words:
deflection testing
falling weight deflectometer
FWD
temperature correction

Strategic Highway Research Program
National Academy of Sciences
2101 Constitution Avenue N.W.
Washington, DC 20418

(202) 334-3774

The publication of this report does not necessarily indicate approval or endorsement of the findings, opinions, conclusions, or recommendations either inferred or specifically expressed herein by the National Academy of Sciences, the United States Government, or the American Association of State Highway and Transportation Officials or its member states.

© 1993 National Academy of Sciences

Acknowledgments

The research described herein was supported by the Strategic Highway Research Program (SHRP). SHRP is a unit of the National Research Council that was authorized by section 128 of the Surface Transportation and Uniform Relocation Assistance Act of 1987.

TABLE OF CONTENTS

	<u>Page</u>
INTRODUCTION	1
FWDCHECK TEMPERATURE CORRECTION PROCEDURE	1
SENSITIVITY ANALYSIS	13
SUMMARY	19
REFERENCES	22

LIST OF FIGURES

<u>Figure</u>		<u>Page</u>
1	Actual Testing Conditions and Pavement Structure	3
2	Hypothetical Trend of Field Temperatures	4
3	Testing Conditions and Pavement Structure Used in Correction Procedure . . .	5
4	Components of Maximum Surface Deflection	9
5	Hypothetical Pavement Sections	14
6	Summary of Sensitivity Analyses Temperature = 20, 60, and 100 °F)	16
7	Effect of AC Thickness on Temperature Correction	17
8	Effect of Subgrade Modulus on Temperature Correction	18
9	Temperature Correction Factor Charts for Flexible Pavements (AC Thickness Range: 2 to 12 inches)	20
10	Temperature Correction Factor Charts for Composite Pavements (AC Thickness Range: 2 to 12 inches)	21

LIST OF TABLES

<u>Table</u>		<u>Page</u>
1	Layer Elastic Modulus as a Function of Material Type	6
2	Values Used in Sensitivity Analysis	15

Abstract

Nondestructive deflection testing using falling weight deflectometers (FWDs) is one element of the monitoring effort currently underway by the Strategic Highway Research Program (SHRP) for the Long-Term Pavement Performance (LTPP) study. Because accurate data are key to the success of the LTPP study, SHRP has implemented a number of measures to ensure the quality of the deflection data. They include equipment comparison and calibration, standardized field testing procedure and field data checks, and quality assurance software.

In turn, the quality assurance software includes a program called FWDCHECK which has been developed to analyze deflection data for, among other things, overall reasonableness from a structural capacity viewpoint. In the case of asphaltic concrete pavements, this structural capacity analysis follows the AASHTO direct structural number procedure. Since asphaltic concrete materials are temperature dependent in nature, measured deflections and hence the structural capacity of the pavement vary with temperature. Thus, a procedure to correct measured maximum deflections to a standard temperature is required so that the comparison of predicted versus expected structural capacities is a valid one. This report documents the temperature correction procedure developed for and used in the FWDCHECK program.

INTRODUCTION

SHRP's Long-Term Pavement Performance (LTPP) study involves extensive monitoring of numerous pavement sections located throughout North America. One aspect of the LTPP data collection is deflection testing, which provides information on structural capacity and material properties. Because accurate data is key to the success of the LTPP study, SHRP has implemented a number of measures to ensure the quality of deflection data. They include: equipment comparison and calibration, standardized field testing procedures and field data checks, and quality assurance software. For the final stage in the quality assurance process, a computer program called FWDCHECK has been developed to analyze deflection data for test section homogeneity, the degree to which test pit data is representative of the section, the presence of data outliers within the section, and overall reasonableness from a structural capacity viewpoint (1).

The last set of deflection data checks in FWDCHECK -- overall reasonableness from a structural capacity viewpoint -- involve the computation of pavement structural capacity and the comparison of the results to what one might expect based on known layer thicknesses and material properties. In the case of flexible (asphalt concrete or AC) pavements, this structural capacity analysis follows the AASHTO direct structural number procedure. The outer deflection basin data are used to estimate the subgrade modulus and this parameter, along with the maximum deflection, is used to directly estimate the effective structural number (SN) of the pavement system.

Because of the temperature-dependent nature of the asphalt concrete modulus, however, measured deflections and hence the structural capacity (or SN value) of the pavement will also vary with temperature. Thus, a procedure to correct the measured maximum deflection to a standard temperature is required so that the comparison of predicted versus expected SN values is a valid one. Also, since the AASHTO structural number or SN value is computed at a standard temperature of 68 F, maximum deflection measured in the field must be corrected to this standard temperature. This report documents the temperature correction procedure developed for and used in the FWDCHECK program.

FWDCHECK TEMPERATURE CORRECTION PROCEDURE

The maximum deflection temperature correction procedure incorporated in the FWDCHECK program is based upon the following relation:

$$Dr = \frac{\delta\sigma_s}{\delta\sigma_f}$$

where Dr = temperature correction factor, $\delta\sigma_s$ = maximum surface deflection at standard temperature of 68°F, and $\delta\sigma_f$ = maximum surface deflection measured in the field (i.e., at test temperature).

The loading, structural and temperature factors affecting the maximum measured deflection, δ_0 , are illustrated in Figure 1. They include:

1. Loading Factors - applied load (P), radius of circular load plate (a_c), and plate contact pressure (p_c).
2. Structural Factors - number of layers (n), layer thicknesses (h_i), layer elastic moduli (E_i), and layer Poisson's ratios (u_i).
3. Temperature Factors - temperature of the asphalt concrete surface layer (T_f); (Note: mid-depth temperature is used in the FWDCHECK program analysis).

The loading factors P, a_c , and p_c are always known for a given deflection basin test (stored in the deflection data file). Layer thicknesses (h_i) are also known from coring and test pit information collected at both ends of the pavement section; they are assumed to remain constant throughout the section. The mid-depth temperature of the AC surface layer (T_f) can be estimated for each deflection basin based on temperature readings taken throughout the test day, at both ends of the pavement section and at various depths; Figure 2 shows a typical trend of mid-depth temperature versus time of testing. The only unknown factors are the layer elastic moduli (E_i) and Poisson's ratios (u_i).

The loading, structural and temperature factors used in the determination of the temperature correction factor are illustrated in Figure 3. Figure 3a represents the actual conditions at the time of testing, T_f , while Figure 3b represents the conditions at the standard temperature of 68°F. The major difference between the two sets of conditions is the mid-depth surface temperature, which in turn affects the elastic modulus of the AC surface layer, E_s , and hence the maximum deflection, δ_0 . The loading factors and layer thicknesses are the same as those measured in the field. Because layer moduli and Poisson's ratios are generally unknown, the following assumptions have been made:

- All layers are homogeneous and linearly elastic (even though non-linearity is built into the FWDCHECK analysis).
- All layers have a Poisson's ratio of 0.5.
- With the exception of the AC surface and subgrade layers, the elastic modulus of all other layers is a constant value defined according to material type; see Table 1.

The subgrade elastic modulus is determined from the composite moduli predicted as a function of geophone location (i.e., radial distance). More specifically, it is assumed that the subgrade modulus is equal to the minimum value in the composite modulus-radial distance relationship. Composite moduli are calculated at each radial distance using the measured deflection basin data as input into Boussinesq's one-layer deflection equation (2):

$$E_c = \frac{2*(1 - \mu_{sg}^2)*p_c*a_c}{\delta}; \quad \text{if } r \leq 0.25a_c \quad (1a)$$

or

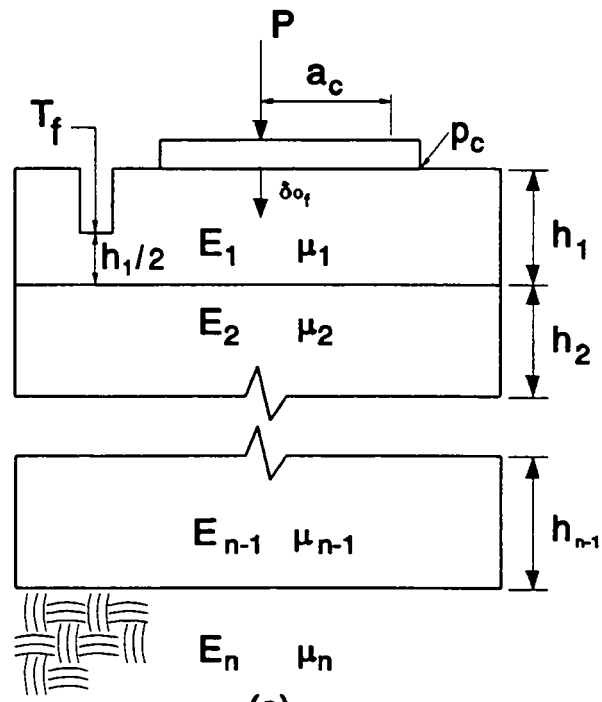

(a)

FIELD CONDITIONS AT
TEMPERATURE = T_f

Figure 1 - Actual Testing Conditions and Pavement Structure

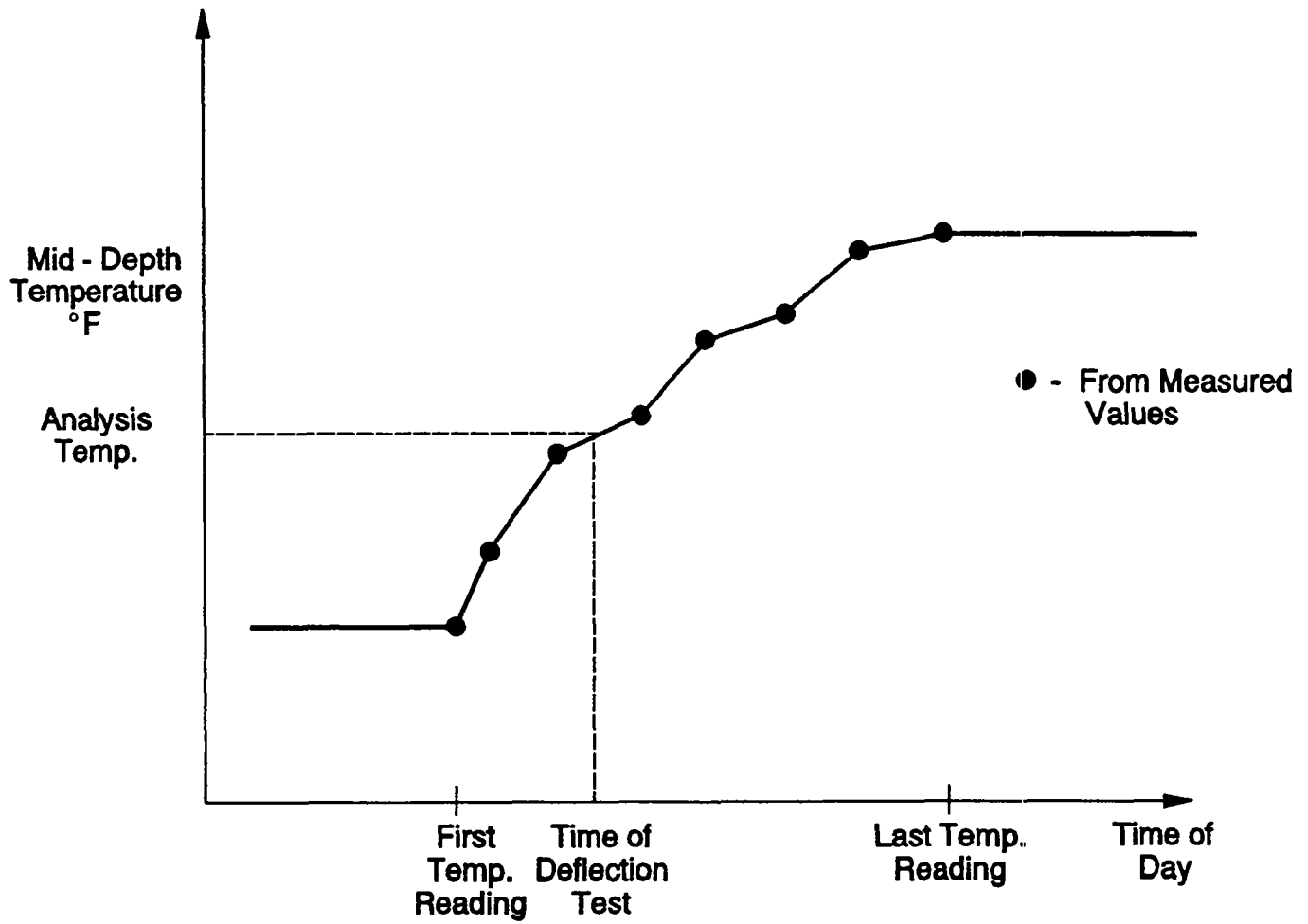

Note: Temperature data is interpolated in order to provide for the best estimate at the time of testing

Figure 2 - Hypothetical Trend of Field Temperatures

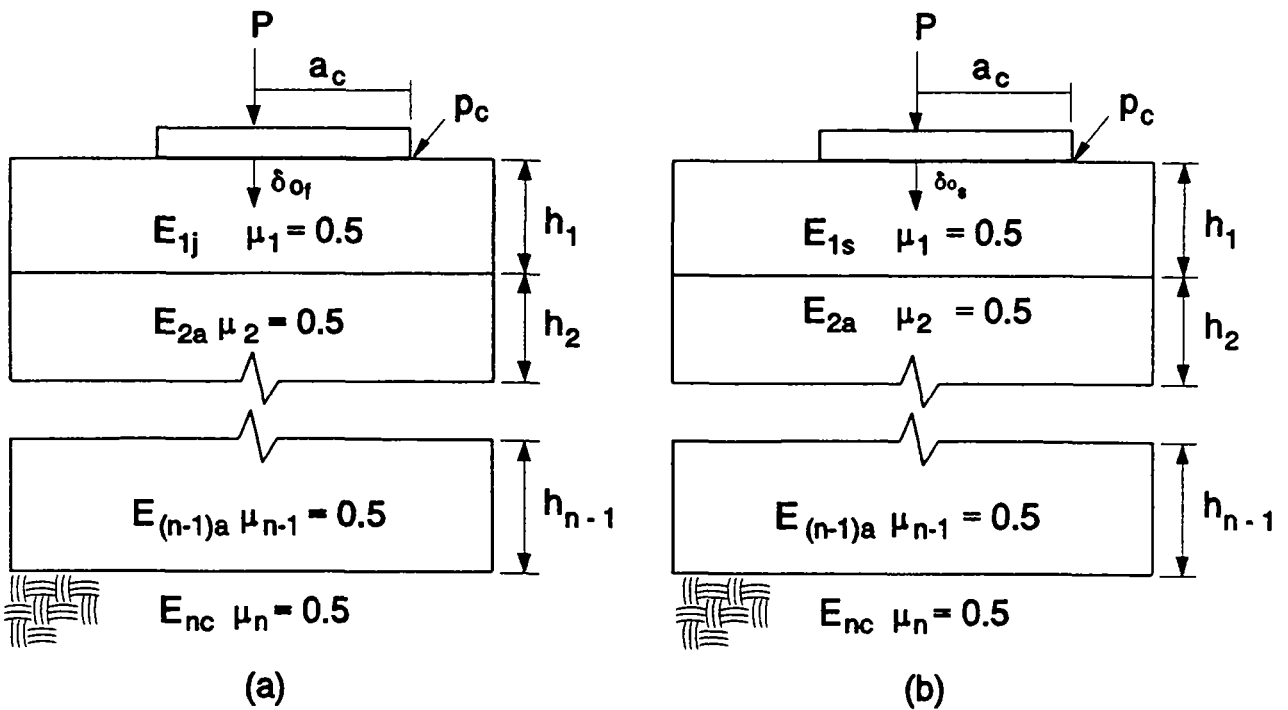

CONDITIONS USED IN MODEL
AT TEMPERATURE = T_f

CONDITIONS USED IN MODEL
AT TEMPERATURE = 68°F

Figure 3 - Testing Conditions and Pavement Structure Used in Correction Procedure

Table 1 - Layer Elastic Modulus as a Function of Material Type

Material Type	Material Code	Elastic Modulus (ksi)
Uncrushed Gravel	302	20.0
Crushed Stone	303	45.0
Crushed Gravel	304	30.0
Crushed Slag	305	50.0
Sand	306	10.0
Fine Soil-Agg. Mixture	307	15.0
Coarse Soil-Agg. Mixture	308	20.0
Sand Asphalt	320	200.0
Asphalt Treated Mixture	321	300.0
Cement Aggregate Mixture	331	750.0
Econcrete	332	1,500.0
Cement Treated Soil	334	100.0
Lean Concrete	336	1,500.0
Sand-Shell Mixture	337	75.0
Limerock, Caliche	338	200.0
Lime Treated Soil	339	75.0
Soil Cement	340	200.0
Pozzolanic-Agg. Mixture	341	500.0
Cracked & Seated PCC	730	1,000.0
Portland Cement Concrete	700	5,000.0

$$E_c = \frac{(1 - \mu_{sg}^2) * p_c * a_c^2}{\delta * r} * C; \quad \text{if } r > 0.25a_c \quad (1b)$$

where:

- E_c = composite modulus;
- r = radial distance;
- p_c = contact pressure applied by NDT device;
- a_c = radius of contact of NDT device;
- μ_{sg} = Poisson's Ratio of the subgrade (= 0.5);
- δ = measured deflection at given radial distance; and
- C = deflection constant equal to the lower of $[1.1\log(r/a_c) + 1.15]$ and $[0.5 * \mu_{sg} + 0.875]$.

The elastic modulus of the asphalt concrete layer, both at field and standard temperatures, is determined by means of the following dynamic modulus predictive equation developed by the Asphalt Institute:

$$\log_{10} E^* = 0.553833 + 0.028829(p_{200})^{f^{-0.17033}} - 0.03476V_a + 0.070377\eta_{70, 10^6} + 0.000005[t_p^{(1.3 * 0.49825\log f_{ac}^{0.5})} - 0.00189[t_p^{1.3 * 0.49825\log f_{ac}^{0.5}} * f^{-1.1}]] + 0.931757f^{-0.02774} \quad (2)$$

where:

- E^* = AC modulus (10^5 psi);
- p_{200} = percent weight passing the No. 200 sieve (%);
- f = test frequency of load wave (cps or Hz);
- V_a = percent air voids in mix (%);
- $\eta_{70, 10^6}$ = AC Viscosity at 70°F (10^6 poises);
- t_p = AC temperature (°F); and
- p_{ac} = percent asphalt content by weight of mix (%).

To simplify the temperature correction analysis, the following typical asphalt concrete properties were assumed:

- p_{200} = 5.0%
- f = 20Hz
- V_a = 4.0%
- $\eta_{70, 10^6}$ = 1.5×10^6 poise
- p_{ac} = 5.0%

Thus, the AC modulus predictive equation (Eq. 1) is reduced to:

$$\log_{10} E = 6.464 - 0.000145t_p^{1.94824} \quad (3)$$

Having established the various loading, structural and temperature factors, the maximum deflection response of the pavement (i.e., directly under the load plate) is predicted for both the assumed field and standard temperature conditions. To accomplish this, a closed form solution was developed based on equivalent layer theory and Boussinesq's one-layer deflection equations. The derivation of this solution is presented below.

The maximum surface deflection is equal to the sum of the compressions of each pavement layer plus the deflection at the interface of the bottom of layer (n-1) and the top of the subgrade, as shown in Figure 4. The compression of each layer is determined by subtracting the interface deflections which occur just above and below the pavement layer. This difference represents the cumulative strain that is contributed by the pavement layer. The remainder of the surface deflection results from strains developed in the underlying layers.

The compression of each pavement layer can be determined in this manner with the exception of the subgrade. If the subgrade is assumed to have an infinite thickness, no compression will occur, therefore 100 percent of the interface deflection at the top of the subgrade contributes to the total surface deflection. Thus, the final equation for the total surface deflection is as follows:

$$\delta'_o = (\delta'_{1T} - \delta'_{1B}) + \sum_{i=2}^{n-1} (\delta'_{iT} - \delta'_{iB}) + \delta'_{nT}$$

where:

- δ'_o = total surface deflection;
- δ'_{1T} = deflection at top of layer 1;
- δ'_{1B} = interface deflection at bottom of layer 1;
- δ'_{iT} = interface deflections at the top of layer i;
- δ'_{iB} = interface deflections at the bottom of layer i; and
- δ'_{nT} = interface deflection at the top of subgrade.

Interface deflections are determined using Boussinesq's one-layer deflection equation. When using these equations, multiple layers are transformed into a single, homogeneous material layer. Specifically, when determining the compression of layer i, all layers above it are transformed into an equivalent material having the same characteristics as layer i (i.e., same E_i and μ_i). The thicknesses of these transformed layers are such that the stiffness of each layer remains the same (i.e., as before the transformation).

The stiffness of any given pavement layer, S, is defined by:

$$S = \frac{E_j h_j^3}{12 (1 - \mu_j^2)} \quad (4)$$

where E_j , h_j and μ_j are the elastic modulus, thickness and Poisson's ratio of layer j, respectively. Thus, if a layer characterized by these properties is transformed into an

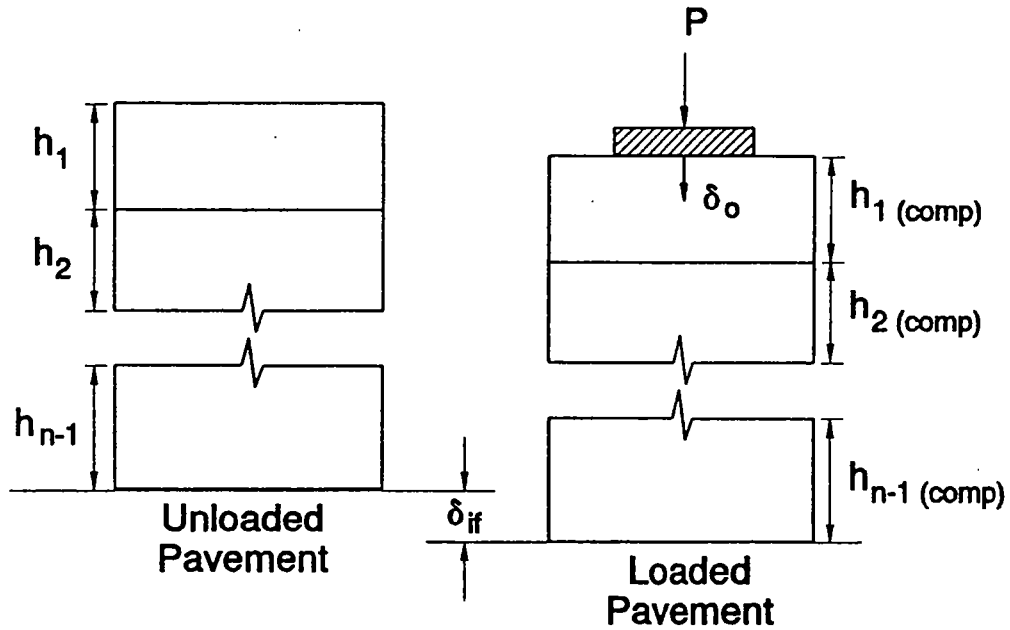

$$\begin{aligned}
 \delta c_1 &= h_1 - h'_1 \\
 \delta c_2 &= h_2 - h'_2 \\
 \delta c_{n-1} &= h_{n-1} - h'_{n-1} \\
 \delta_{if} &= \delta_{if} \\
 \hline
 \delta_0 &= \delta c_1 + \delta c_2 + \dots + \delta_{n-1} + \delta_{if}
 \end{aligned}$$

Note: $h'_{i(\text{comp})}$ as shown in the above illustration refers to the compressed layer thickness after the pavement is loaded.

Figure 4 - Components of Maximum Surface Deflection

equivalent material (having E_i , h_i and μ_i) but the stiffness remains the same, the following relationship must hold true:

$$\frac{E_j h_j^3}{12(1 - \mu_j^2)} = \frac{E_i h_i^3}{12(1 - \mu_i^2)}$$

Or, rearranging the transformed thickness equation, h_i' can be solved as follows:

$$h_i' = h_j \sqrt[3]{\frac{E_j(1 - \mu_i^2)}{E_i(1 - \mu_j^2)}} \quad (5)$$

Furthermore, if the Poisson's ratio of all layers is assumed to be $\mu_i = \mu_j = 0.5$, then the transformed thickness equation is reduced to:

$$h_i' = h_j \sqrt[3]{\frac{E_j}{E_i}} \quad (6)$$

To compensate for errors inherent in this approximate procedure, an adjustment factor, α , is typically incorporated into the thickness transformation equation:

$$h_i' = \alpha h_j \sqrt[3]{\frac{E_j}{E_i}}$$

where:

$$\alpha = 1 - \frac{\log\left(\frac{E_j}{E_i}\right)}{7.5h_j^{0.2}}$$

The α function used in the FWDCHECK temperature correction procedure was determined by comparing (and analyzing) deflection results generated from hundreds of Chevron runs with those generated using the transformed section approach discussed next. The results typically ranged from $\alpha = 0.8$ to 0.9 .

In the case of a one-layer pavement system, the maximum deflection directly under the center of the load plate can be estimated from the following Boussinesq equation:

$$\delta_{r=0, z=0} = \frac{p_c a_c^2 (1 - \mu^2)}{E} F_b \quad (7)$$

where:

- z = depth from surface;
- r = radial distance from load; and
- F_b = Boussinesq one-layer deflection factor, which in turn is defined by:

$$F_b = \left(\sqrt{1 + \left(\frac{h}{a_c}\right)^2} - \left(\frac{h}{a_c}\right) \right) \left(1 + \frac{\left(\frac{h}{a_c}\right)}{2(1 - \mu) \sqrt{1 + \left(\frac{h}{a_c}\right)^2}} \right) \quad (8)$$

If the Poisson's ratio for this one-layer system is assumed to be $\mu = 0.5$, then the above equation is reduced to:

$$\delta_{r=0, z \geq 0} = \frac{0.75p_c a_c^2}{E} \frac{1}{\sqrt{1 + \left(\frac{h}{a_c}\right)^2}} \quad (9)$$

However, since pavement structures generally consist of multiple layers, the concepts of layer thickness transformations and interface deflections must be incorporated into the Boussinesq one-layer deflection equation. The maximum surface deflection is determined as follows:

1. The first layer (i.e., AC surface) of the pavement structure does not require transformation because no layers lie above it. Therefore, the interface deflections at the top and bottom of the layer (δ'_{1T} and δ'_{1B}) are defined by:

$$\delta'_{1T} = \frac{0.75p_c a_c^2}{E_1}$$

and

$$\delta'_{1B} = \frac{0.75p_c a_c^2}{E_1} \left(\frac{1}{\sqrt{1 + \left(\frac{h_1}{a_c}\right)^2}} \right) = \frac{0.75p_c a_c^2}{E_1} F_{b1B}$$

where E_1 , h_1 and μ_1 are the elastic modulus, thickness and Poisson's ratio of the AC surface layer.

2. To determine the interface deflections for each of the remaining pavement layers above the subgrade, all layers above the one in question (i.e., layer i) are transformed into an equivalent, single material characterized by E_i and μ_i . This process is shown below:

$$h'_i = \sum_{j=1}^{i+1} h_j \sqrt[3]{\frac{E_j}{E_i}}$$

$$\delta'_{iT} = \frac{0.75p_c a_c^2}{E_i} \left(\frac{1}{\sqrt{1 + \left(\frac{h'_i}{a_c}\right)^2}} \right) = \frac{0.75p_c a_c^2}{E_1} F_{iT}$$

and

$$\delta'_{iB} = \frac{0.75p_c a_c^2}{E_i} \left(\frac{1}{\sqrt{1 + \left(\frac{h'_i + h_i}{a_c}\right)^2}} \right) = \frac{0.75p_c a_c^2}{E_1} F_{iB}$$

where E_j , h_j and ν_j are the elastic modulus, thickness and Poisson's ratio of layer j .

3. The interface deflection at the top of the subgrade, δ_{nT} , is determined as follows:

$$h'_n = \sum_{j=1}^{n-1} h_j \sqrt[3]{\frac{E_j}{E_n}}$$

$$\delta'_{nT} = \frac{0.75p_c a_c^2}{E_n} \left(\frac{1}{\sqrt{1 + \left(\frac{h'_n}{a_c}\right)^2}} \right) = \frac{0.75p_c a_c^2}{E_n} F_{nT}$$

4. As indicated earlier, the maximum surface deflection is equal to the sum of the compression in each layer plus the interface deflection at the top of subgrade:

$$\delta_o = (\delta'_{1T} - \delta'_{1B}) + \sum_{i=2}^{n-1} (\delta'_{iT} - \delta'_{iB}) + \delta_{nT}$$

Substituting the interface equations (presented in Steps No. 1 through 3 above) into the maximum surface deflection equation yields:

$$\delta_o = 0.75p_c a_c^2 \left(\frac{1}{E_1} (1 - F_{b1B}) + \sum_{i=2}^{n-1} \frac{1}{E_i} (F_{b1T} - F_{b1B}) + \frac{1}{E_n} F_{b1T} \right) \quad (10)$$

This last equation is used in the FWDCHECK temperature correction procedure to estimate both the maximum surface deflection at field temperature, δ_{of} , and the maximum surface deflection at the standard temperature of 68°F, δ_o . The only difference in these two calculations is the elastic modulus assigned to the AC surface layer -- E_{1f} (at field temperature) and E_{1s} (at 68°F). In turn, the temperature correction factor, D_r , is determined from δ_{of} and δ_o , as follows:

$$D_r = \frac{\delta_{o_s}}{\delta_{o_f}} = \frac{\frac{1}{E_{1s}} (1 - F_{b1B}) + \sum_{i=2}^{n-1} \frac{1}{E_i} (F_{b1T} - F_{b1B}) + \frac{1}{E_n} F_{b1T}}{\frac{1}{E_{1f}} (1 - F_{b1B}) + \sum_{i=2}^{n-1} \frac{1}{E_i} (F_{b1T} - F_{b1B}) + \frac{1}{E_n} F_{b1T}} \quad (12)$$

This factor is only used to temperature correct maximum deflections, after the subgrade modulus has been established.

SENSITIVITY ANALYSIS

In order to assess the influence of the various factors used to determine the temperature correction factor, D_r , a sensitive analysis was undertaken. These factors included:

1. Asphalt Concrete thickness (when used as a surface layer)
2. Layer moduli (other than surface layer)
3. Layer Poisson's ratio

Deflection temperature correction factors were first determined for the four hypothetical structures shown in Figure 5, which include two and three layer flexible structures and two and three layer composite structures. The influence of each parameter on the temperature correction factor was determined by varying the values shown in Figure 5 to those shown in Table 2.

The analysis results are summarized in Figure 6. As can be observed, changes in the thickness of the asphalt concrete layer and the elastic modulus of the subgrade have the greatest effect on the temperature correction factor, D_r . The impact of these two factors upon D_r is further illustrated in Figures 7 and 8, which show the change in D_r due to changes in either AC layer thickness or subgrade modulus and temperature. The remaining factors, E_i and μ_i , had little to no effect on D_r (up to 7% change in D_r , see Figure 6).

It should be noted that when determining the temperature correction factor, the asphalt concrete modulus is predicted from the Asphalt Institute dynamic modulus equation and the subgrade modulus is calculated from the outer geophone deflection readings. Therefore,

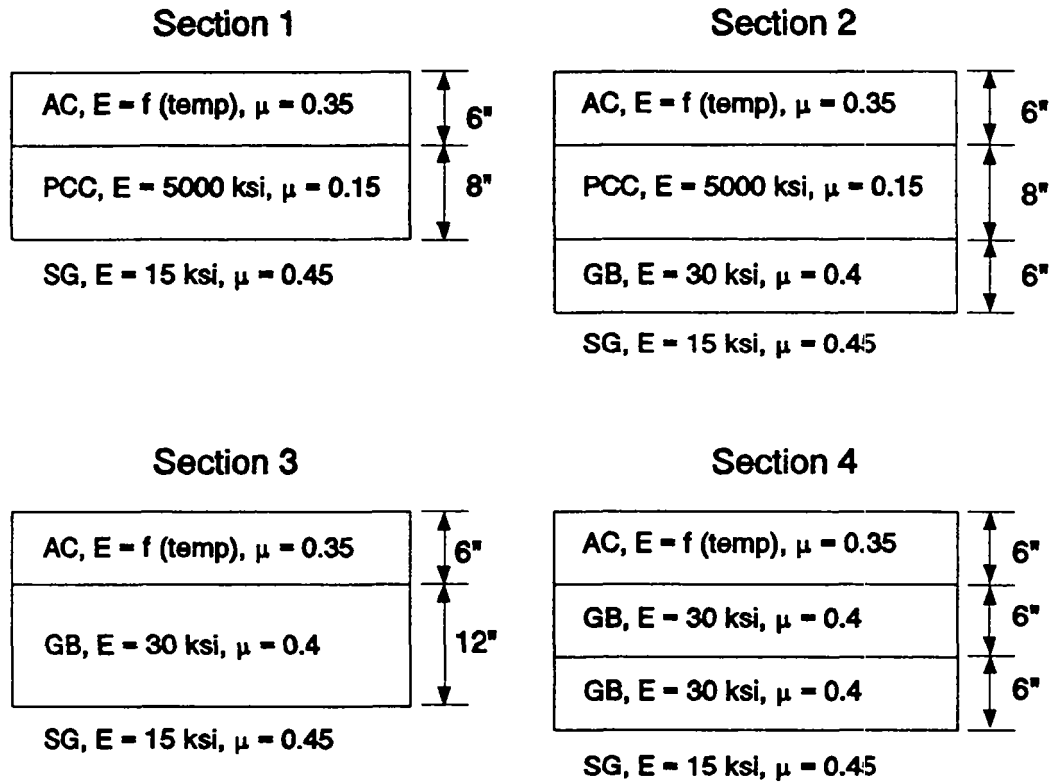

AC = Asphalt Concrete
 GB = Granular Base
 PCC = Portland Cement Concrete
 SG = Subgrade

Figure 5 - Hypothetical Pavement Sections

Table 2 - Values Used in Sensitivity Analysis

Parameter	Section 1			Section 2			Section 3			Section 4		
	Min	Max	Inc	Min	Max	Inc	Min	Max	Inc	Min	Max	Inc
Temperature, °F	0	120	10	0	120	10	0	120	10	0	120	10
AC Thickness, inches	2	12	2	2	12	2	2	12	2	2	12	2
Base Course Elastic Modulus, ksi	1000	10000	1000	1000	10000	1000	10	100	10	10	100	10
Subbase Course Elastic Modulus, ksi	N/A	N/A	N/A	10	100	10	N/A	N/A	N/A	10	100	10
Subgrade Course Elastic Modulus, ksi	5	50	5	5	50	5	5	50	5	5	50	5
Surface Course Poisson's Ratio	0.3	0.5	0.05	0.3	0.5	0.05	0.3	0.5	0.05	0.3	0.5	0.05
Base Course Poisson's Ratio	0.1	0.5	0.05	0.1	0.5	0.05	0.3	0.5	0.05	0.3	0.5	0.05
Subbase Course Poisson's Ratio	N/A	N/A	N/A	0.3	0.5	0.05	N/A	N/A	N/A	0.3	0.5	0.05
Subgrade Course Poisson's Ratio	0.3	0.5	0.05	0.3	0.5	0.05	0.3	0.5	0.05	0.0	0.5	0.05

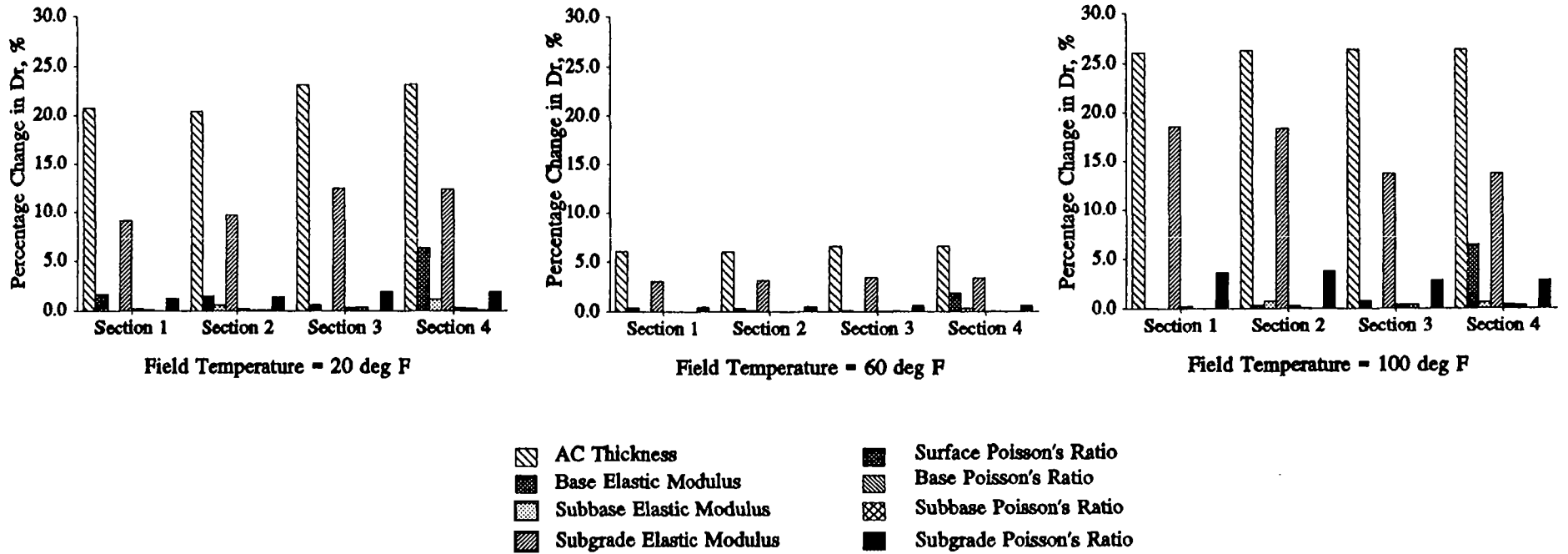

Figure 6 - Summary of Sensitivity Analyses (Temperature = 20, 60, and 100°F)

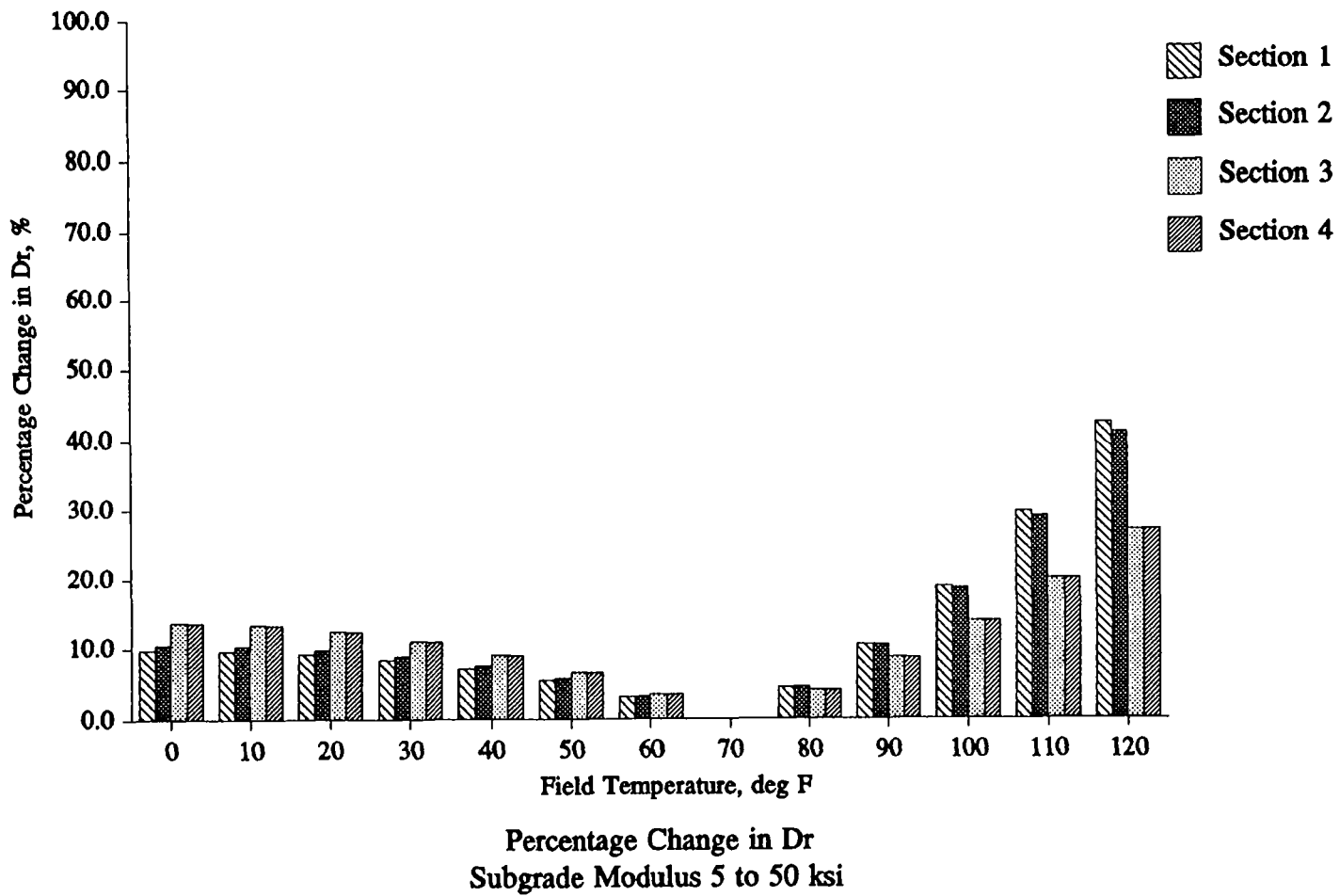

Figure 7 - Effect of Subgrade Modulus on Temperature Correction

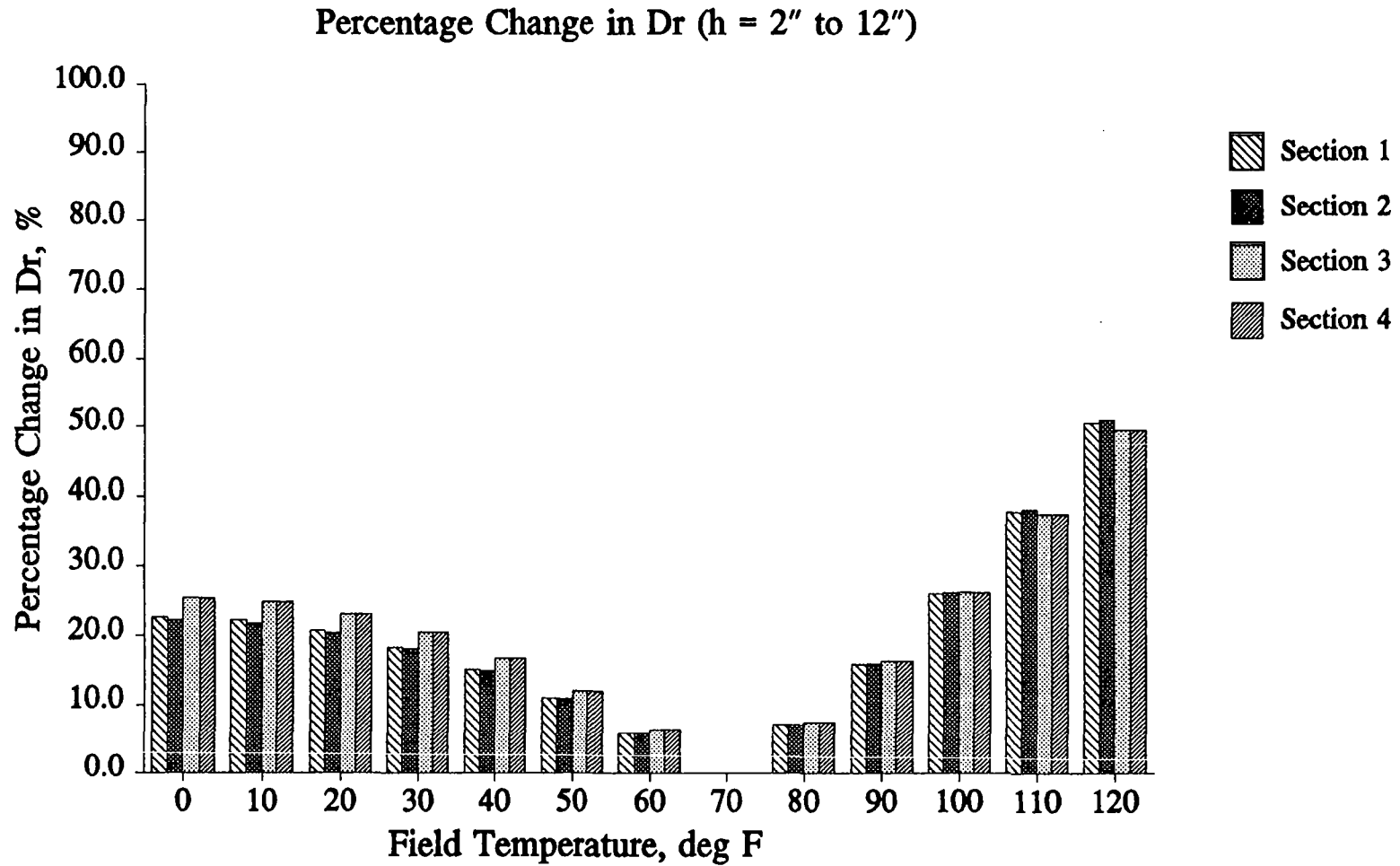

Figure 8 - Effect of AC Thickness on Temperature Correction

changes in D_r are accurate when due to changes in AC thickness and subgrade modulus. Alternatively, the parameters that are assumed in the procedure -- E_2 through E_{n-1} and μ_i through μ_n -- have little effect on the resulting temperature correction factor.

Typical temperature correction curves have been developed for flexible pavements with weak subgrade support, flexible pavements with strong subgrade support, composite pavements with weak subgrade support and composite pavements with strong subgrade support based on analysis results. These curves are shown in Figures 9 and 10. In them, a weak subgrade soil is defined as having an elastic modulus of 10 ksi or less, while a strong subgrade soil is defined as having a modulus greater than 20 ksi. Prior to implementation, however, it is recommended that temperature correction curves be developed for a wider range of anticipated subgrade modulus values.

SUMMARY

A temperature correction procedure has been developed and implemented in the FWDCHECK software to correct measured maximum surface deflections to a standard temperature. Documentation of the procedure is included in the text of this report. A summary of some of the features of the procedure are listed below:

- The procedure is based on a multi-layer analysis so that the properties of each layer within the pavement structure are considered.
- Only the change in the compression of the AC surface layer due to temperature changes is considered in the procedure.
- The multi-layer procedure considers the incompressibility of PCC layers much better than the original two-layer procedure.
- Values assumed in the procedure -- E_i and μ_i for base and subbase layers -- have very little to no effect on the resulting temperature correction factor.
- Predictions of the AC modulus as a function of temperature are based on the Asphalt Institute procedures (3).
- The procedure can be made more accurate if properties of the AC mix are known.
- The estimate of the subgrade modulus, which has an effect on D_r , is based on actual deflection measurements (outer geophone readings).

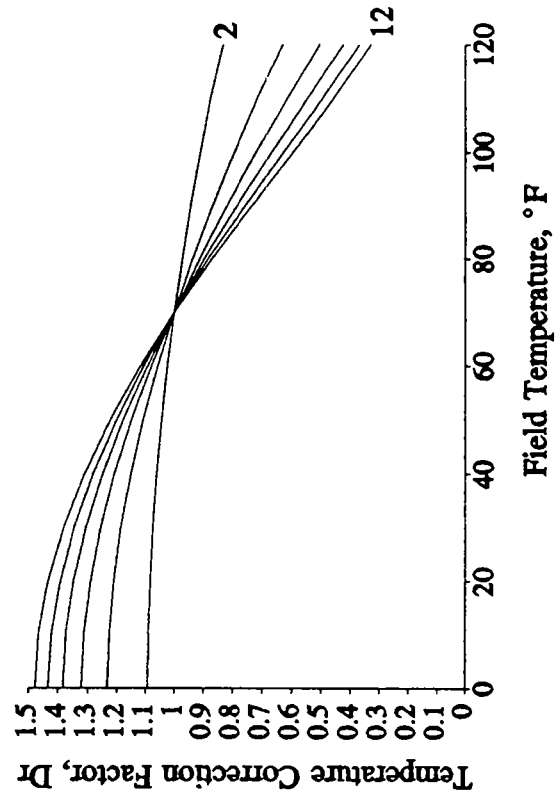

Flexible Pavements - Strong Subgrade

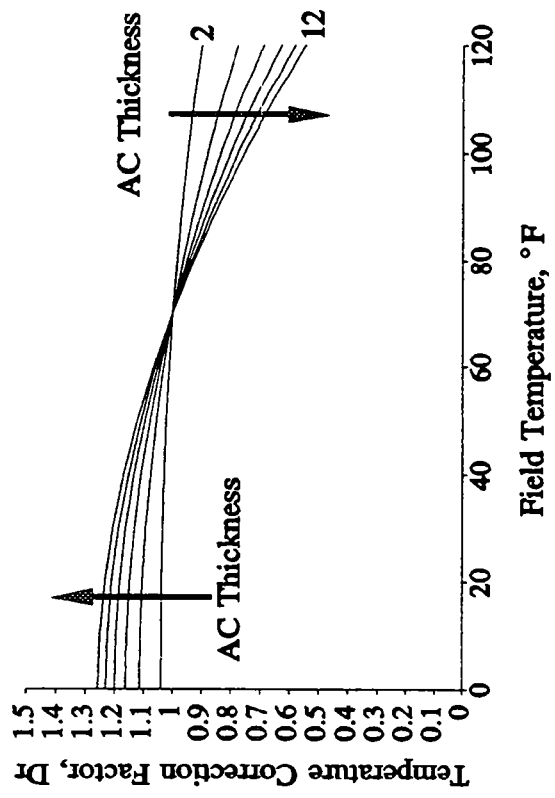

Flexible Pavements - Weak Subgrade

Figure 9 - Temperature Correction Factor Charts for Flexible Pavements

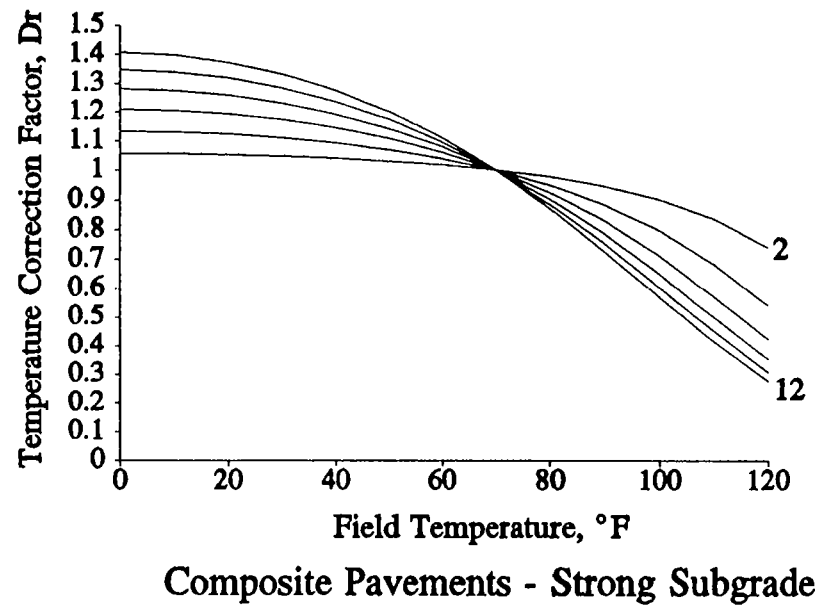
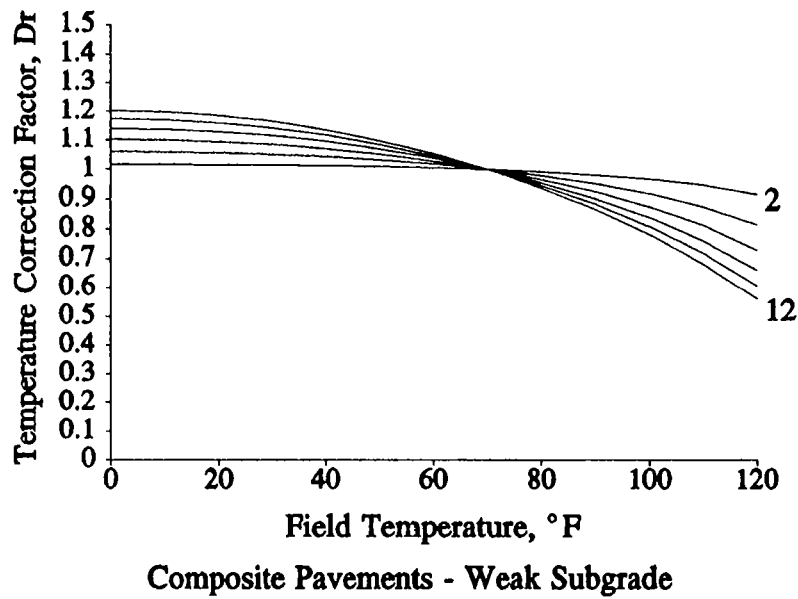

Figure 10 - Temperature Correction Factor Charts for Composite Pavements

REFERENCES

1. Strategic Highway Research Program: Analysis of Section Homogeneity, Non-Representative Test Pit and Section Data, and Structural Capacity - FWDCHECK, Version 2.00, Strategic Highway Research Program, April 1992.
2. Rada, G.R., Witzak, M.W. and Rabinow, S.D., "A Comparison of AASHTO Structural Evaluation Techniques using NDT Deflection Testing", TRB, Transportation Research Record 1207, Washington, D.C., 1988.
3. The Asphalt Institute, "Research and Development of The Asphalt Institute's Thickness Design Manual (MS-1) Ninth Edition", Research Report No. 82-2, College Park, Maryland, August 1982.

Long-Term Pavement Performance Advisory Committee

Chairman

William J. MacCreery
W.J. MacCreery, Inc.

David Albright
Alliance for Transportation Research

Richard Barksdale
Georgia Institute of Technology

James L. Brown
Pavement Consultant

Robert L. Clevenger
Colorado Department of Highways

Ronald Collins
Georgia Department of Transportation

Guy Dore
Ministere des Transports de Quebec

Charles E. Dougan
Connecticut Department of Transportation

McRaney Fulmer
*South Carolina Department
of Highways and Public Transportation*

Marlin J. Knutson
American Concrete Pavement Association

Hans Jorgen Ertman Larsen
Danish Road Institute, Road Directorate

Kenneth H. McGhee
Consultant Civil Engineer

Raymond K. Moore
University of Kansas

Richard D. Morgan
National Asphalt Pavement Association

William R. Moyer
Pennsylvania Department of Transportation

David E. Newcomb
University of Minnesota

Charles A. Pryor
National Stone Association

Cesar A.V. Queiroz
The World Bank

Roland L. Rizenbergs
Kentucky Transportation Cabinet

Gary K. Robinson
Arizona Department of Transportation

Frederic R. Ross
Wisconsin Department of Transportation

Ted M. Scott
American Trucking Association

Marshall R. Thompson
University of Illinois

Kenneth R. Wardlaw
Exxon Chemical Corporation

Marcus Williams
H.B. Zachry Company

Liaisons

Albert J. Bush, III
USAE Waterways Experiment Station

Louis M. Papet
Federal Highway Administration

John P. Hallin
Federal Highway Administration

Ted Ferragut
Federal Highway Administration

Frank R. McCullagh
Transportation Research Board

Expert Task Group

Paul D. Anderson
Mountainview Geotechnical Ltd.

Robert C. Briggs
Texas Department of Transportation

Albert J. Bush, III
USAE Waterways Experimental Station

Billy G. Connor
Alaska Department of Transportation

William Edwards
Ohio Department of Transportation

John P. Hallin
Federal Highway Administration

Frank L. Holman, Jr.
Alabama Highway Department

William J. Kenis
Federal Highway Administration

Joe P. Mahoney
University of Washington

Larry A. Scofield
Arizona Transportation Research Center

Richard N. Stubstad
Dynatest Consulting, Inc.

Marshall R. Thompson
University of Illinois

Per Ullidtz
Technical University of Denmark

Jacob Uzan
Texas A&M University

Wes Yang
New York State Department of Transportation